

liaison

Sara Moroni

S M L XL

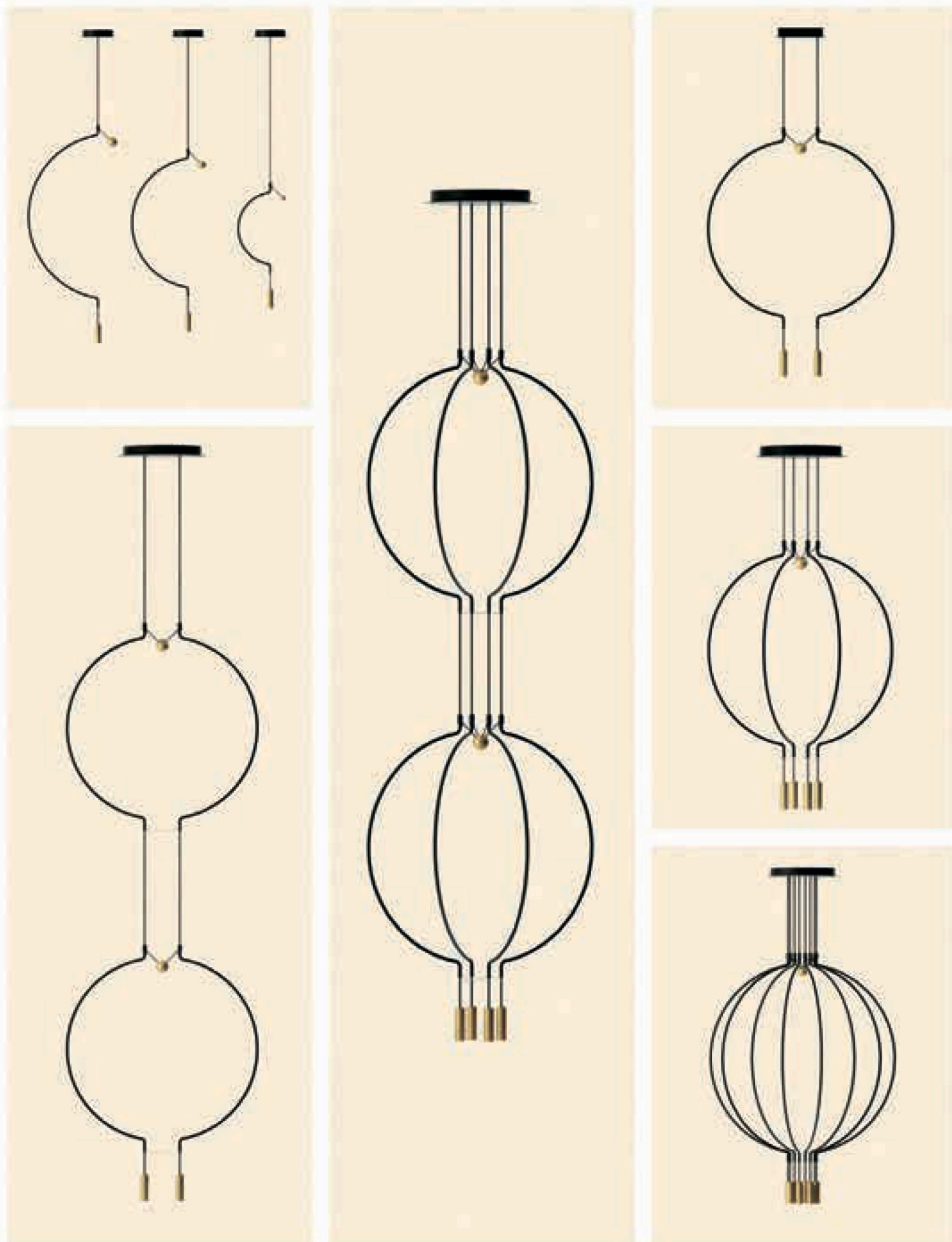

liaison

Sara Moroni

Collezione di lampade a sospensione in metallo. Disponibile in vari colori e dimensioni. La sorgente luminosa è a LED integrato dimmerabile.

Collection consisting of metal suspended lamps. Available in several colors and sizes. Built-in dimmable LED light source.

GENERAL INFORMATION



DRIVER INCLUDED *EXCEPT FOR THE RECESSED VERSION

FINISHINGS FINITURE



black / matt gold
nero / oro opaco

matt gold / black
oro opaco / nero

black / black
nero / nero

liaison

Sara Moroni

SP LIAI P 1
kg 1,766 m³ 0,05

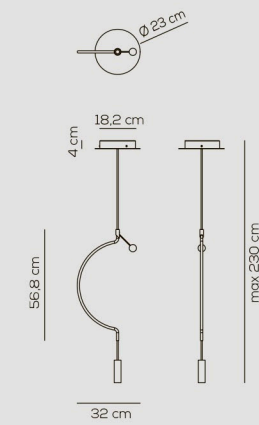

SP LIAI M 1
kg 2,181 m³ 0,09

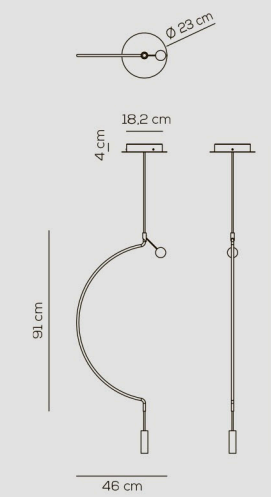

SP LIAI G 1
kg 2,448 m³ 0,16

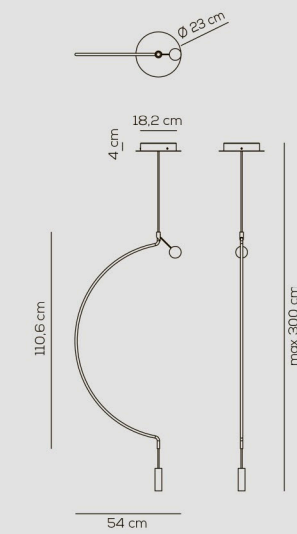

Arch / Final & sphere finishes
NE black / NE black
NE black / OO matt gold
OO matt gold / NE black

3000K*
2700K upon request

optic ~40° beam

LED 1 x 6,7W
~ 671 lm* ~ 100 lm/W* source

220-240VAC

example composition code
SP LIAI P 1 NE NE LED

SP LIA P 1 (RECESSED)*
kg 1,5 m³ 0,05

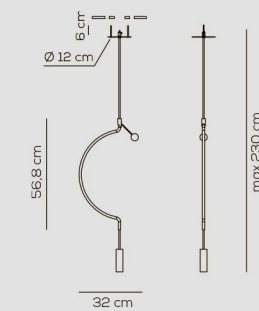

SP LIA M 1 (RECESSED)*
kg 1,9 m³ 0,09

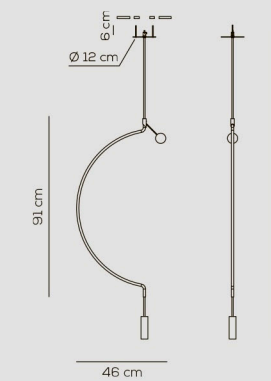

SP LIA G 1 (RECESSED)*
kg 2,2 m³ 0,16

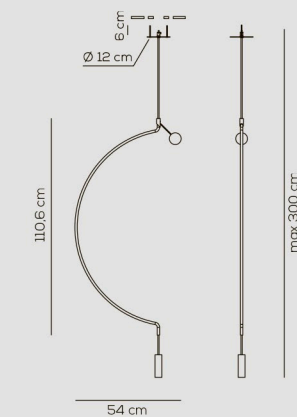

 EAC in progress

LIAISON - COMPATIBLE WITH
PIVOT SYSTEM / DRIVER NOT
INCLUDED

Arch / Final & sphere finishes
NE black / NE black
NE black / OO matt gold
OO matt gold / NE black

3000K*
2700K upon request

optic ~40° beam

LED 1 x 6,7W
~ 671 lm* ~ 100 lm/W* source



700mA - 9,4Vdc

example composition code
SP LIA P 1 NE NE LED

foro - hole: 1 x Ø 3 cm + 2 x Ø 1,4 cm
profondità min - min depth 10 cm

SPLIAIP1NEOLED

optional accessories for recessed versions

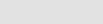
-  **CEDLTC00124** dimmable Phase Cut 700mA driver - Max 20W trailing and leading edge
-  **CEDLTC00127** dimmable 0/1 - 10V - Push - 700mA driver - Max 9W
-  **CEDLTC00126** dimmable DALI 700mA driver - Max 20W
-  **CEDLTC00104** dimmable DALI 700mA driver - Max 50W

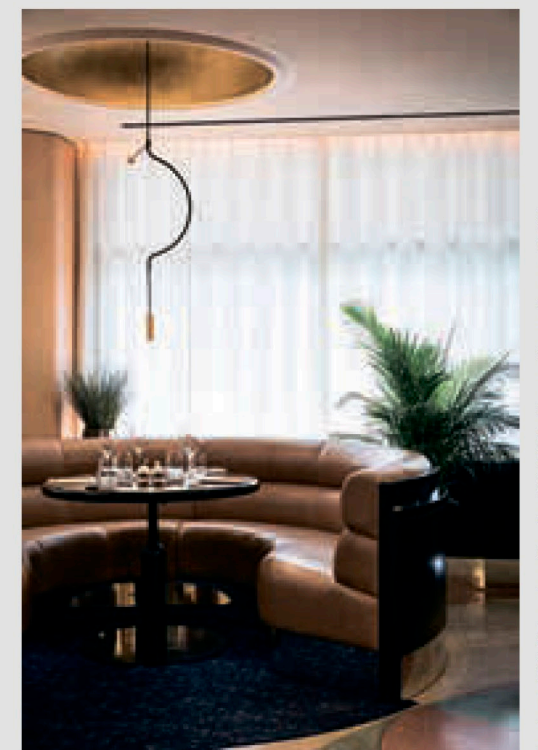

Project: FOLIE London Studio KO 2019. Photo: Yann Deret-2521

SPLIAM2NEOLED



liaison

Sara Moroni

SP LIAI P 2
kg 2,549 m³ 0,05

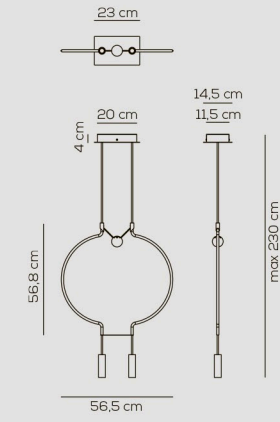

SP LIAI M 2
kg 2,673 m³ 0,09

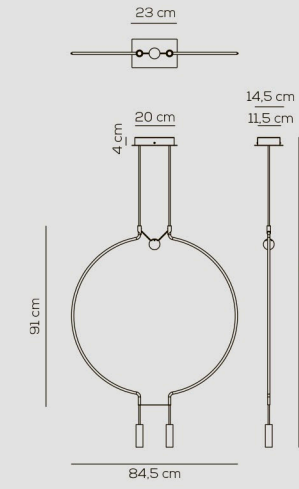

SP LIAI G 2
kg 2,734 m³ 0,16

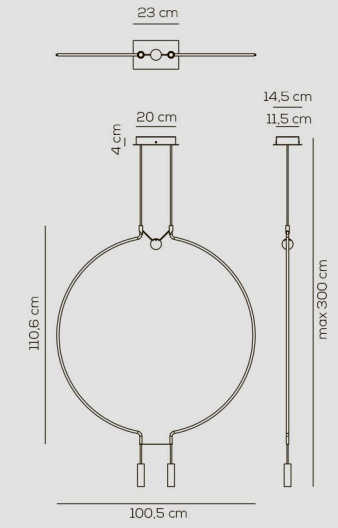

Arch / Final & sphere finishes
NE black / NE black
NE black / OO matt gold
OO matt gold / NE black

3000K*
2700K upon request

optic ~40° beam

LED 2 x 6,7W
~ 1342 lm* ~ 100 lm/W* source

220-240VAC

example composition code
SP LIAI P 2 NE NE LED



SPLIAIM4OONELED



liaison

Sara Moroni

SP LIAI P 4
kg 5,697 m³ 0,11

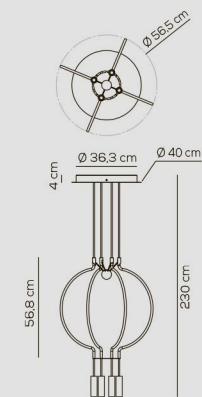

SP LIAI M 4
kg 5,945 m³ 0,1

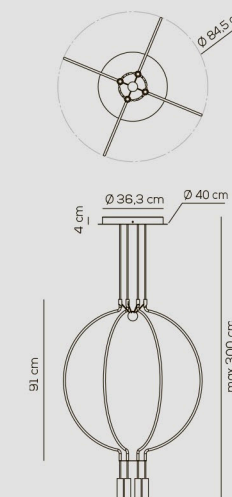

SP LIAI G 4
kg 6,068 m³ 0,2

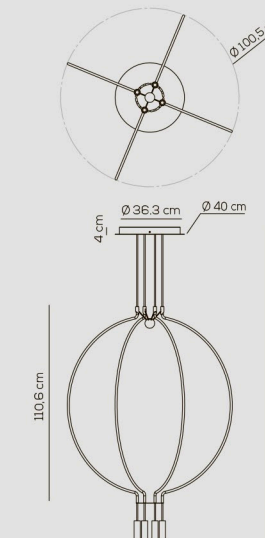

Arch / Final & sphere finishes
NE black / NE black
NE black / OO matt gold
OO matt gold / NE black

3000K*
2700K upon request

optic ~40° beam

LED 4 x 6,7W
~ 2684 lm* ~ 100 lm/W* source

220-240VAC

example composition code
SP LIAI P 4 NE NE LED

SP LIAI P 8
kg 7,914 m³ 0,11

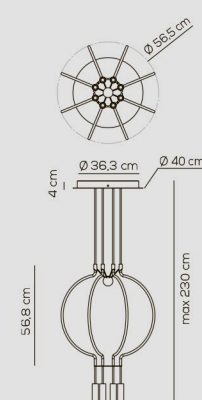

SP LIAI M 8
kg 8,41 m³ 0,24

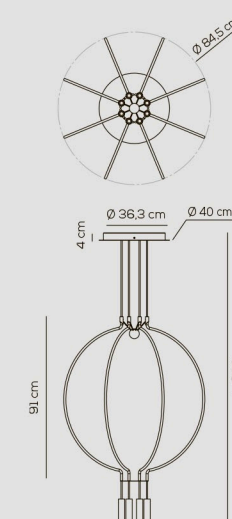

SP LIAI G 8
kg 8,656 m³ 0,36

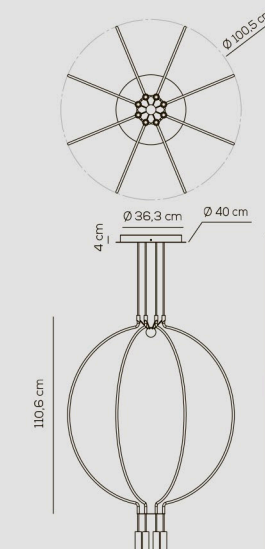

Arch / Final & sphere finishes
NE black / NE black
NE black / OO matt gold
OO matt gold / NE black

3000K*
2700K upon request

optic ~40° beam

LED 8 x 6,7W
~ 5368 lm* ~ 100 lm/W* source

220-240VAC

example composition code
SP LIAI P 8 NE NE LED

SPLIAG8NEOOLED



SPLIADG2NEOOLED

liaison

Sara Moroni

SP LIAD P 2
kg 3,678 m³ 0,07

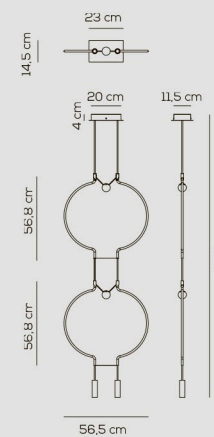

SP LIAD M 2
kg 4,12 m³ 0,09

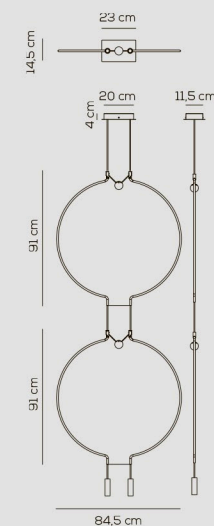

SP LIAD G 2
kg 4,28 m³ 0,16

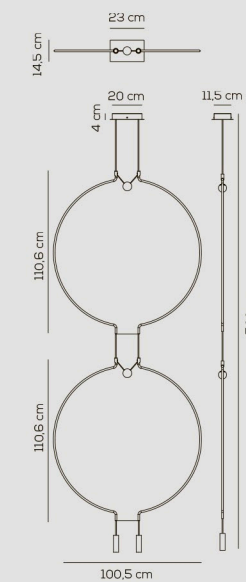

Arch / Final & sphere finishes
NE black / NE black
NE black / OO matt gold
OO matt gold / NE black

3000K*
2700K upon request

optic ~40° beam

LED 2 x 6,7W
~ 1342 lm* ~ 100 lm/W* source

220-240VAC

example composition code
SP LIAD P 2 NE NE LED

Project: Zanette Photo: Daniele Di Pietro per Riccardo Munari in Studio

SPLIADG8NEOOLED



Project: GAO Architects Photo: Miron Kambić

SP LIAD P 4
kg 7,355 m³ 0,09

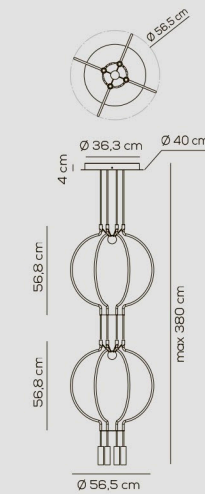

SP LIAD M 4
kg 8,241 m³ 0,24

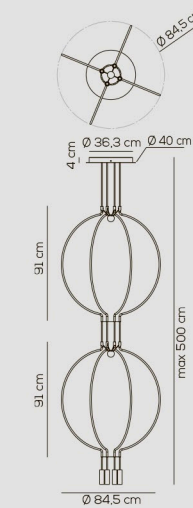

SP LIAD G 4
kg 8,559 m³ 0,17

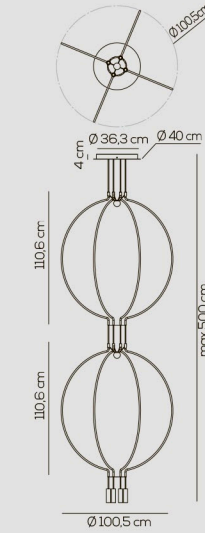

Arch / Final & sphere finishes
NE black / NE black
NE black / OO matt gold
OO matt gold / NE black

3000K*
2700K upon request

optic ~40° beam

LED 4 x 6,7W
~ 2684 lm* ~ 100 lm/W* source

220-240VAC

example composition code
SP LIAD P 4 NE NE LED

SP LIAD P 8
kg 10,631 m³ 0,09

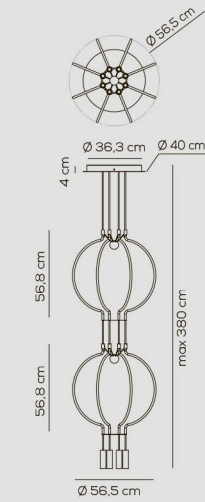

SP LIAD M 8
kg 12,401 m³ 0,24

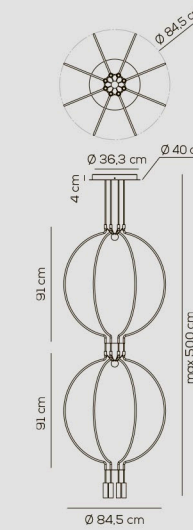

SP LIAD G 8
kg 13,039 m³ 0,17

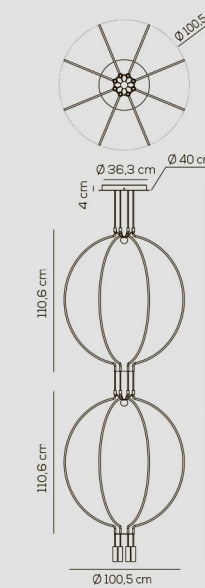

Arch / Final & sphere finishes
NE black / NE black
NE black / OO matt gold
OO matt gold / NE black

3000K*
2700K upon request

optic ~40° beam

LED 8 x 6,7W
~ 5368 lm* ~ 100 lm/W* source

220-240VAC

example composition code
SP LIAD P 8 NE NE LED